

ROTATOR GR16S

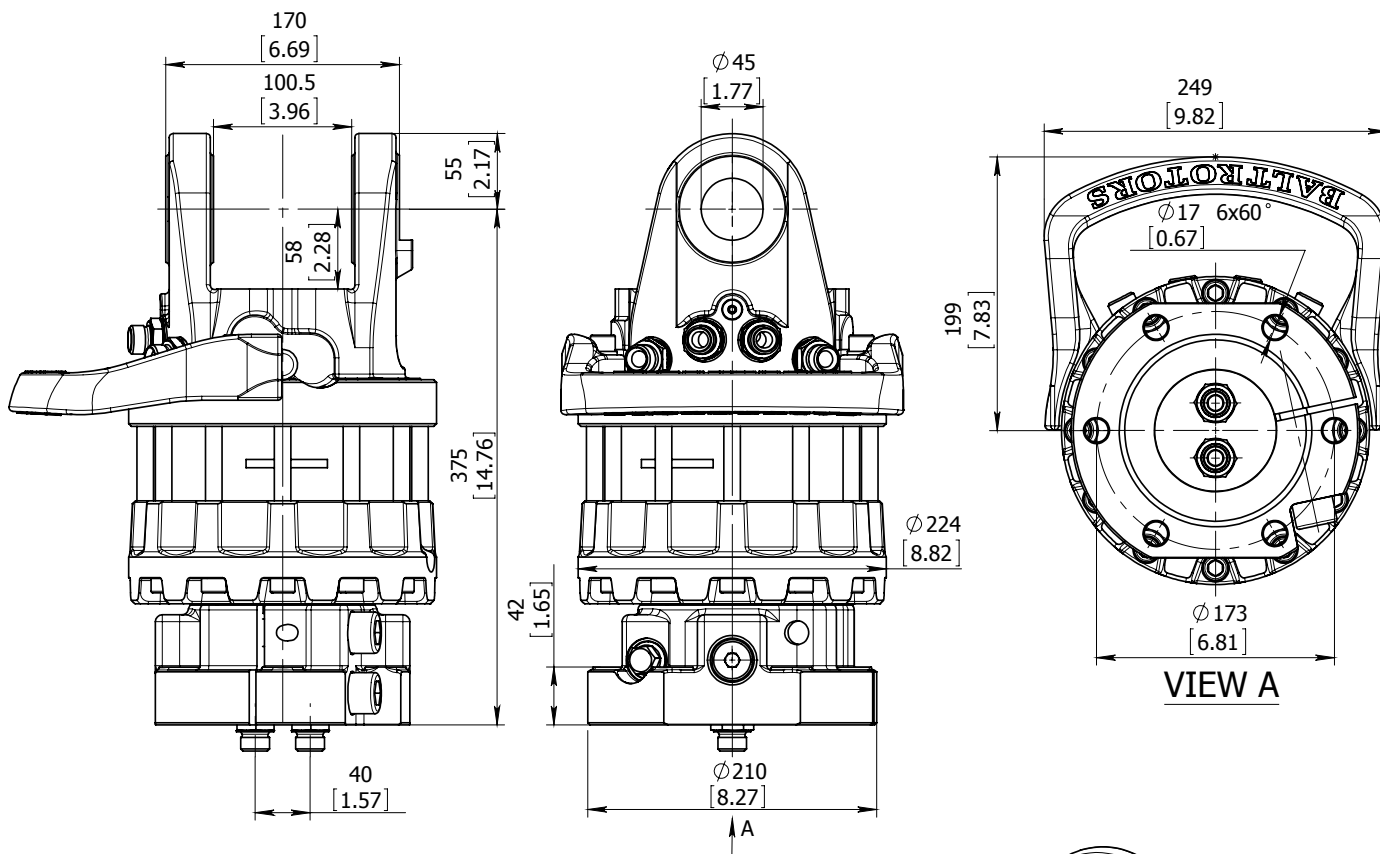

Technical data

Rotation	Unlimited
Max axial load static, KN (lbf)	+160 (35976) - 90 (20236)
Max axial load dynamic, KN (lbf)	+80 (17988) - 45 (10118)
Torque at 25Mpa (3625psi), Nm (lb ft)	3400 (2500)
Rec oilflow, l/min (US gallon)	40 (10.6)
Weight, kg (lb)	71 (157)

Max working pressure:

Rotator	←R→	Max 25 MPa (3625 psi)	G 1/2"
Grapple / Tool open	←G→	Max 30 MPa (4350 psi)	G 1/2"
Grapple / Tool close	→G←	Max 30 MPa (4350 psi)	G 1/2"

Connection:

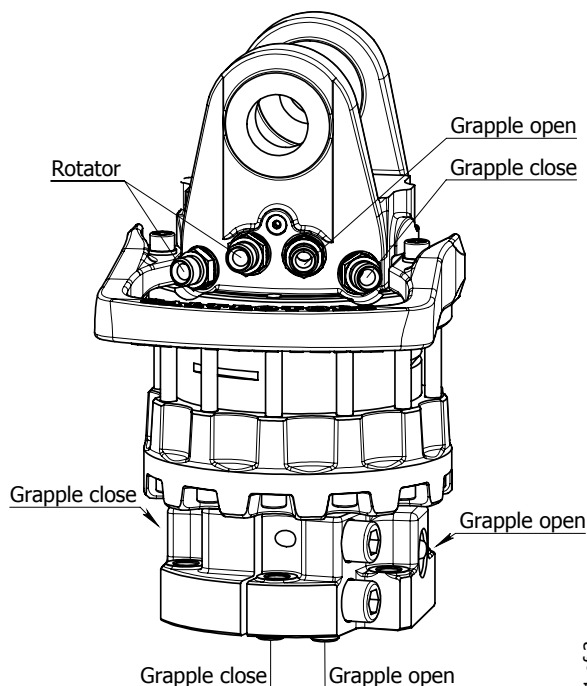

Sheet 1 of 3

2011.10.05.