

INDUSTRIAL ROTATOR **CPR9-01**

(PATENTED)

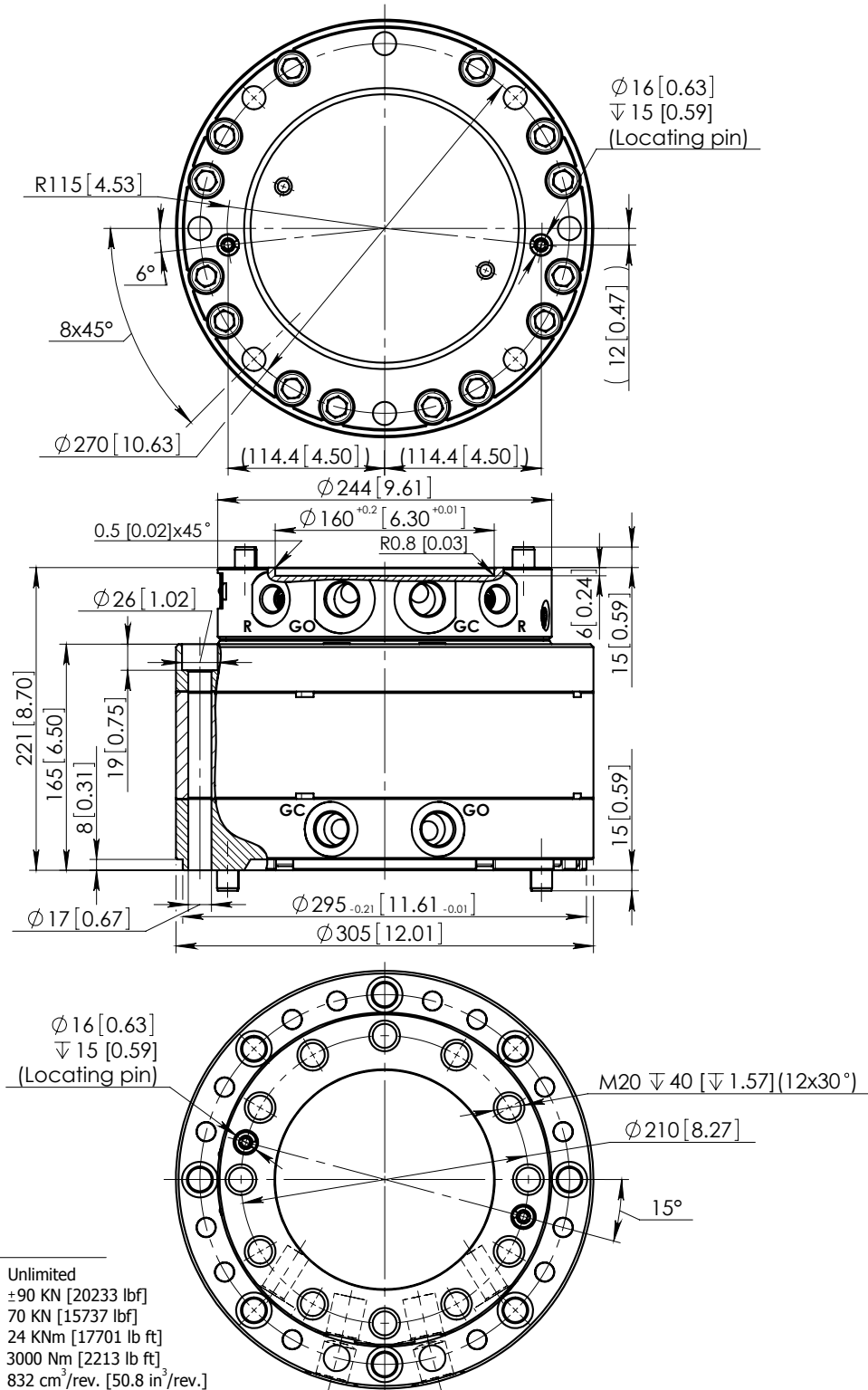

Technical data

Rotation	Unlimited
Max axial load	± 90 KN [20233 lbf]
Max radial load	70 KN [15737 lbf]
Moment of deflection	24 KNm [17701 lb ft]
Torque at 25 Mpa	3000 Nm [2213 lb ft]
Rated displacement	832 cm ³ /rev. [50.8 in ³ /rev.]
Rotation speed	max 30 rpm
Oil duct area for grapple	150 mm ² [0.232 in ²]
Weight	101 kg [222 lb]

Function	Max working pressure	Rec oilflow	Connection
R - rotation	25 MPa [3625 psi] *	30 l/min [7.9 gal(US)/min]	G 1/2
GO - grapple/tool open	35 MPa [5076 psi]		G 3/4
GC - grapple/tool close	35 MPa [5076 psi]		G 3/4

* Relief valves fitted