

# INDUSTRIAL ROTATOR **CPR8-01**

(PATENTED)

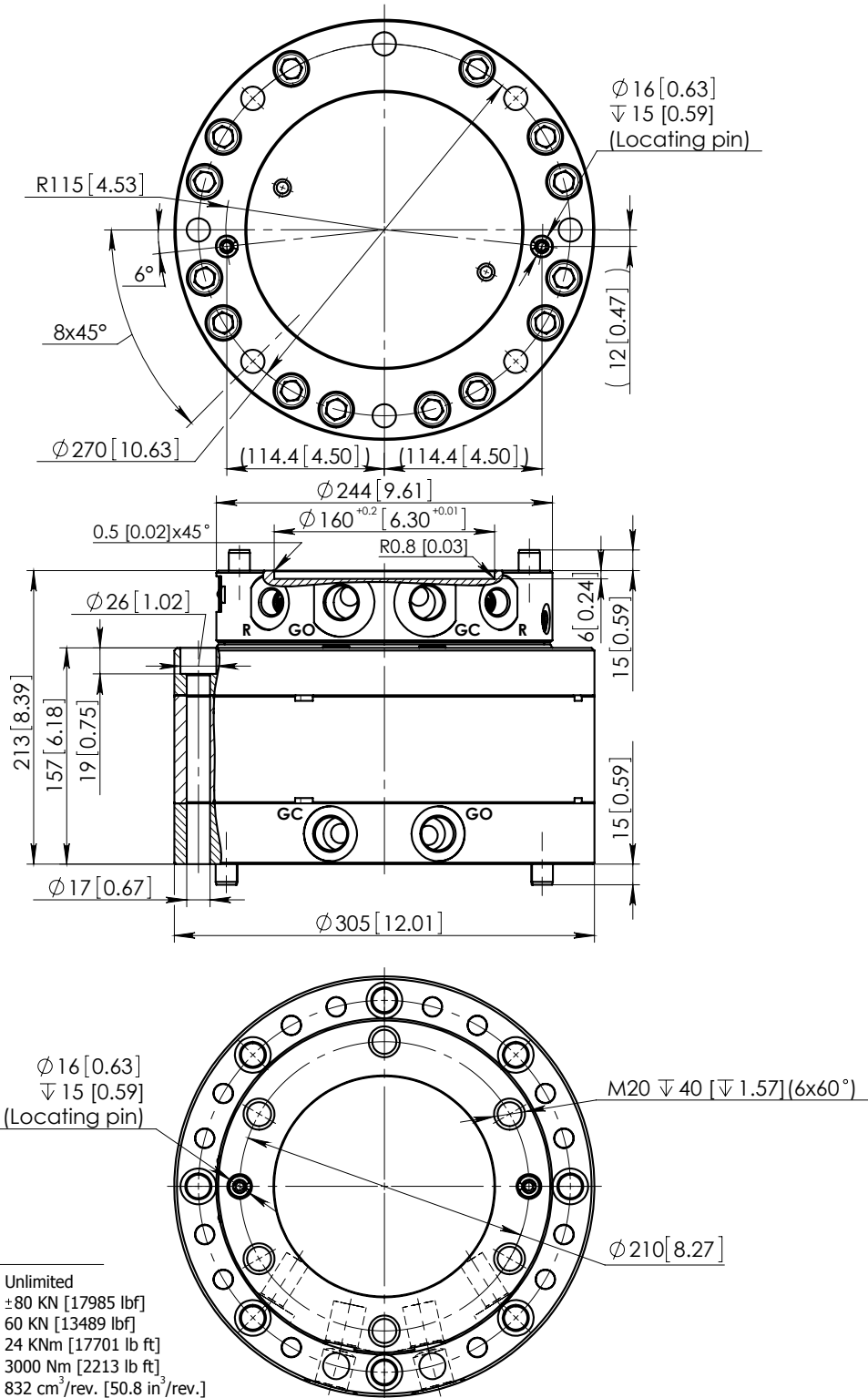

## Technical data

Rotation	Unlimited
Max axial load	±80 kN [17985 lbf]
Max radial load	60 kN [13489 lbf]
Moment of deflection	24 kNm [17701 lb ft]
Torque at 25 Mpa	3000 Nm [2213 lb ft]
Rated displacement	832 cm <sup>3</sup> /rev. [50.8 in <sup>3</sup> /rev.]
Rotation speed	max 30 rpm
Oil duct area for grapple	150 mm <sup>2</sup> [0.232 in <sup>2</sup> ]
Weight	99 kg [217 lb]

Function	Max working pressure	Rec oilflow	Connection
<b>R</b> - rotation	25 MPa [3625 psi] *	30 l/min [7.9 gal(US)/min]	G 1/2
<b>GO</b> - grapple/tool open	35 MPa [5076 psi]		G 3/4
<b>GC</b> - grapple/tool close	35 MPa [5076 psi]		G 3/4

\* Relief valves fitted